

UV222 Downlight

(Filtered Far UV-C)

Technical & Installation Manual

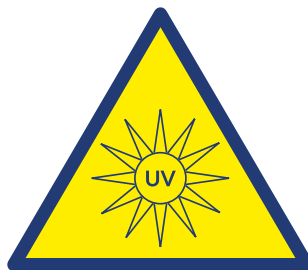



CAUTION UV LIGHT

THE PRODUCT AS DESCRIBED HEREIN CONTAINS COMPONENTS THAT EMIT FILTERED FAR UV LIGHT.

DO NOT USE THE PRODUCT BEFORE CAREFULLY READING THIS MANUAL.

ALWAYS KEEP THIS MANUAL WITH THE PRODUCT AND CONSULT IT REGULARLY.

Contents

1. USING THIS MANUAL – GENERAL	3
1.1 BASIC SAFETY INSTRUCTIONS	4
2. DISCLAIMERS	5
3. SAFETY INSTRUCTIONS AND WARNINGS	5
3.1. User manual	5
3.2. Intended use and installation	5
3.3. Safety features of the Product	5
3.4. Modification	6
4. GENERAL CHARACTERISTICS AND TECHNICAL SPECIFICATIONS	6
5. CONSTRUCTION	7
6. INSTALLATION OF THE PRODUCT	8
6.1. Choose the appropriate location	8
6.2. Unboxing and inspection	8
6.3. Product installation	9
6.4. Understanding the unit's operation	10
6.5. Setting up the Product	10
6.6. Understanding the function of the signal LED	19
6.7. Replacements	19
7. PRODUCT FAILURE	20
8. CLEANING AND MAINTENANCE	20
9. LIGHT SOURCE REPLACEMENT	21
10. REPAIRS	21
11. RECYCLING & DISPOSAL	21
Warranty	21
NOTES	22

ATTENTION

Lumière UV émise par cet appareil.

Évitez de regarder directement la lampe en cours d'utilisation.

CAUTION

UV Light emitted from this device.

Avoid looking directly at the light.

IEC/TR 62471-2:2009

1. USING THIS MANUAL – GENERAL

This manual (hereinafter referred to as the “Manual”) is intended to be used as work of reference for professional, well trained and authorised users to be able to safely install and use the product mentioned on the cover of this document (hereinafter referred to as the “Product”). The observation of the Manual does not dispense the user from the observance of the local safety instructions and regulations other than provided by the Manual. Such safety instructions and regulations must be observed at all time.

For information about specific adjustments, maintenance or repair jobs which are not dealt with in this manual, please contact your Product supplier or UV Medico A/S.

If you suspect that the Product is damaged or detect a potential or actual danger when using the Product, immediately discontinue use of the Product and contact your supplier of the Product.



1.1. BASIC SAFETY INSTRUCTIONS

To minimise the risk of injury, the following basic safety precautions should be observed with each use of the Product:

Only operate the Product if you have read and understood the Manual and are aware of the content of all current legal regulations (ISO 15858 and TLVs® and BEIs® from the ACGIH).

Do not remove the sticker on the front of the unit until the Product is commissioned by a qualified installer.

**Do not put any object in close front of the surface of the Product.
Do not put plastic or glass in front of the Product. It does not transmit UV.
Make sure the Product has an unobstructed path towards the area to be disinfected.**

Do not use flammable substances near the lamp module.
This is an electronic device. Do not use flammable or combustible gases or liquids, such as oxygen, hydrogen, or chemicals, near the Product. Failure to obey may result in fire or explosion.

**Do not turn on any Product with a broken front glass.
If the front glass is broken, disconnect the Product immediately and contact an authorised installer.**

Do not disassemble or modify the lamp module.
Disassembly or modification may result in fire, electric shock, or injury.

Turn off the electrical power during lamp module maintenance.

Do not remove any safety labelling or parts.

Do not touch the lamp module during operation.
Otherwise, it may result in fire, electric shock, or injury.

Ground the device or metal parts of the housing that are close to the lamp module.
Otherwise, it may result in fire, electric shock, or injury.

Do not use the unit for purposes other than disinfection.
The unit is designed for disinfection. Using it for any other purpose may result in unexpected accidents.

Avoid looking directly at the light.

2. DISCLAIMERS

UV Medico A/S with registered office at Søren Frichs Vej 50, 8230 Åbyhøj - Denmark, or any of its affiliates, does not accept any liability for material damage, including damage to the Product or personal injury caused by non-observance by the user of the safety instructions in the Manual or the applicable laws. As such UV Medico A/S shall among others not be liable for any damage or injury if the Product is used contrary to or for purposes other than its intended use, is installed, used, maintained or repaired negligently or contrary to the instructions mentioned in the Manual or on the Product; also in the case the Product is modified, and when safety devices and features are disregarded or overridden.

3. SAFETY INSTRUCTIONS AND WARNINGS

3.1. User manual

Every person using the Product must read and understand the contents of the Manual and familiarise themselves with it before any use of the Product, and must strictly observe the instructions set out herein. If you are an employee or are acting on behalf of another person, your employer/that person must instruct you in accordance with the Manual and ensure that all instructions set out herein are complied with.
Do not use the Product if that is not the case.

3.2. Intended use and installation

The Product is intended exclusively for air and surface disinfection. Using the Product for other purposes is contrary to its intended use and is done at own risk.

To ensure safe use of the Product, its installation, including all its safety features and devices, and its maintenance and repair must be carried out correctly by a qualified installer. All of the Product safety features and devices must be mounted and may not be removed but for the purpose of maintenance and repair.

The Product is not intended to be used by minors. Any use of the Product by minors, regardless of whether or not under the supervision of an adult, is at own risk.

3.3. Safety features of the Product

Each Product is equipped with the following safety features:

- Motion sensor: To detect motion.
- Lidar sensor: To measure distance to the occupancy of the room.
- Multicolour LED: To signal the operation and state of the unit.

It is strictly forbidden to override these safety devices or to use the Product if the safety features are not fully present or disfunction.

The safety features should be regularly checked for their proper functioning, and if required, be immediately repaired or replaced.

The pictograms, warnings and instructions attached to the Product are part of its safety features. They must not be covered or removed and must be present and legible during the entire use of the Product.

Immediately replace or repair missing, damaged or illegible pictograms, warnings and instructions.

3.4. Modification

No modification of the product is allowed. All warranty and liability are void if any modifications are done to the Product.

4. GENERAL CHARACTERISTICS AND TECHNICAL SPECIFICATIONS

The Product is designed to emit Far UV-C radiation with a wavelength of 222 nm, in order to eliminate viruses, bacteria, fungi, and other pathogens, from air and surfaces.

The Far UV-C lamps are designed for 17,500+ hours of efficient operation. Far UV-C lamps used longer than this, may no longer emit the required level of ultraviolet radiation to ensure the desired germicidal efficacy on harmful microorganisms.

Technical data

Light source	Kr-Cl Excimer lamp
Wavelength	222 nm
UV output power (60°)	115 mW (typical)
UV output power (100°)	70 mW (typical)
Input voltage	85-305V AC 50/60 Hz
Max power consumption	17 W
Weight	1.6 kg (3.5 lbs)
Dimensions	Ø 178 mm x 129 mm (Ø 7 in x 5 in)
Power lead	3 x 0.75 mm ² (18AWG)
Operating temperature	0 to +50°C (32° to 122° F)
Ambient humidity	5-90% RH Non condensing

5. CONSTRUCTION

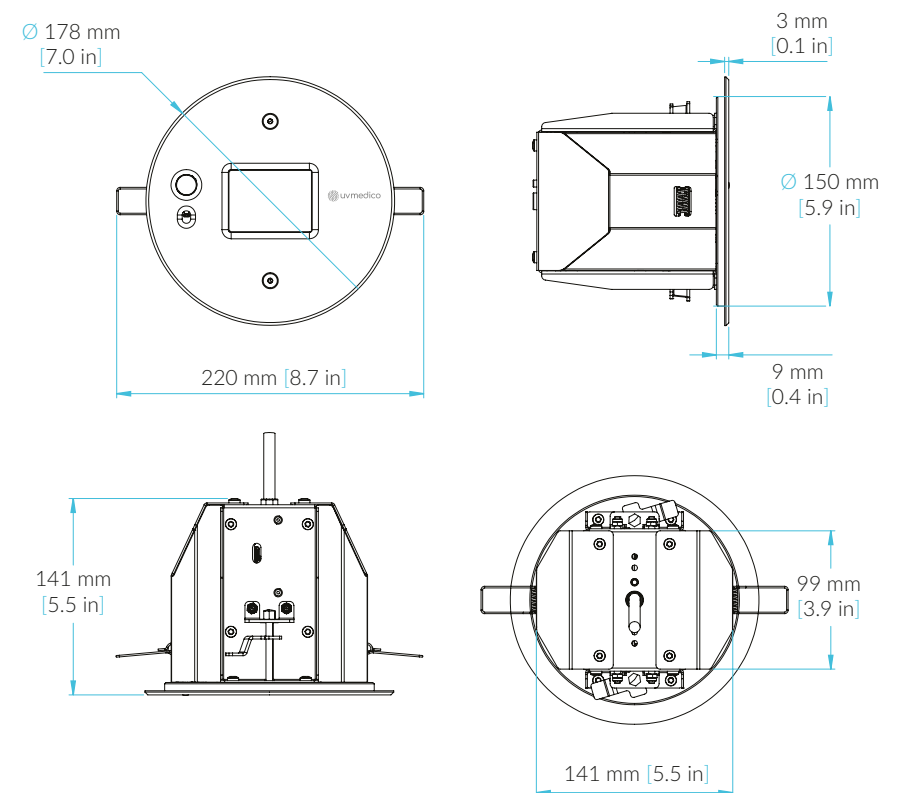

6. INSTALLATION OF THE PRODUCT

Perform the following steps for the installation of the Product.

Outside every room where Far UV-C light is used, there must be information signs in clear line of sight.

Installation must be done according to the local regulations by a qualified installer.

6.1. Choose the appropriate location

Choosing the appropriate location is important for the proper functioning and safe use of the Product.

A DIALux simulation can help you to choose the right position for disinfection.

Install the Product in a protected area where the temperature does not fall below 0° C (32° F) and the humidity level is low. The Product functions ideally in a temperature range from 0°C to +50° C (32° to 122° F).

Select a mounting location that is close to surface/area that you want to disinfect.

6.2. Unboxing and inspection

Read and save all notices, warnings and safety instructions received with the Product.

Open the box and carefully take the unit out of the box. Take the unit out of the plastic bag. Do not remove the protection label on the front of the Product. The protection label is intended to avoid unexpected UV radiation. Make a visual inspection of the unit.

Do not power on the unit until installed by a qualified installer!



CAUTION: Do not touch the glass of the lamp without gloves. Doing so may result in damage to the lamp. Oil from fingerprints will permanently etch the glass of the lamp and weaken the structure.

6.3. Product installation

The unit must be inserted on a suspended ceiling or similar surface that can fit the unit and support its weight, preferably near electrical wires with grounding.

The diameter of the opening should be between 150 and 155 mm.

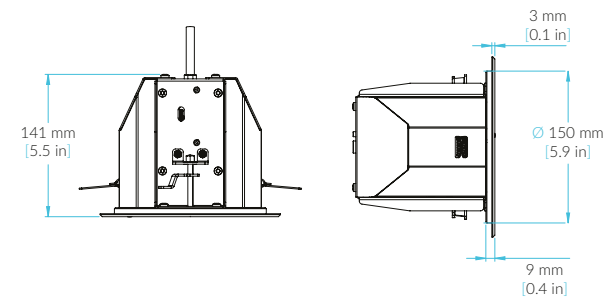

Once the Product is connected to a power source, push the side springs and insert in the opening made on the ceiling panel.

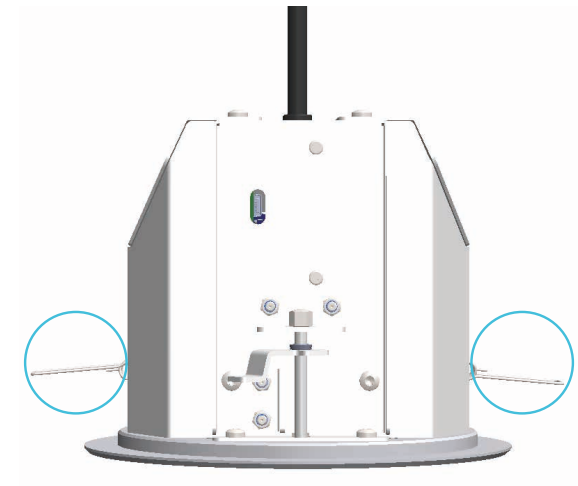

6.4. Understanding the unit's operation

The maximum permissible UV-C exposure shall not exceed the ACGIH TLV and NIOSH REL of 22,0 mJ/cm² for an 8 h day, 40 h work week exposure to UV radiation at 222 nm. (UV Medico A/S expects positive changes into the ACGIH that will result in a higher exposure than allowed at this moment. If this changes, UV Medico A/S will update the software of the unit to align with the new threshold of exposure).

To achieve the correct radiation within these limits, following information will be programmed into the Product before the start-up of this installation.

6.5. Setting up the Product

The installer will need a Microsoft Windows computer with the UVMEDICO application installed. Contact your distributor to get access to the latest software and firmware for the Product.

To launch the app, go to the installed folder and open the file:

UV Medico Configuration App.exe

The app includes two different set up modes: simple and advanced.

For the simple mode, follow the instructions that will appear on the screen.

For the advanced mode, see below:

There is a USB-C connection **A** on the side of the unit to connect to a computer with a USB cable.

Connect your computer to the unit and it will show up automatically on the application.

When the app is launched, following steps needs to be taken:

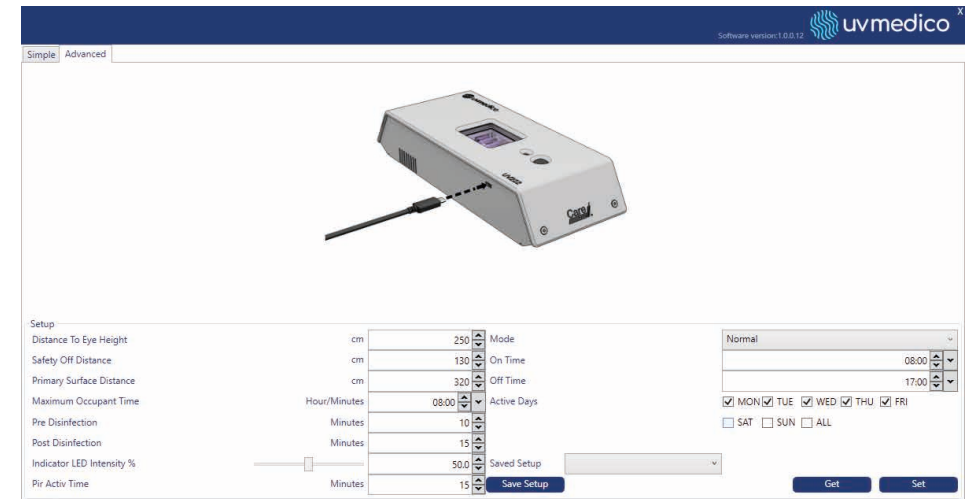
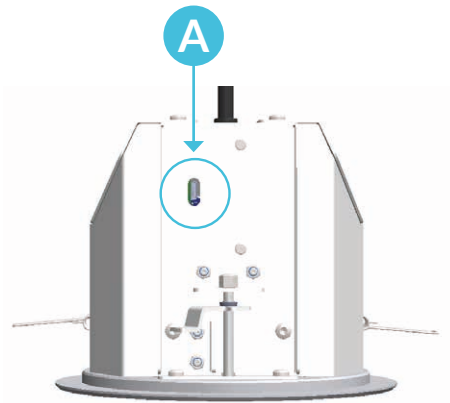

1) If the Product was already installed, you can read out the setting of the unit by pressing "Get" all settings will be shown in the application. **B**

2) Check if the firmware version is the latest. If not, click on "Update FW". **C**

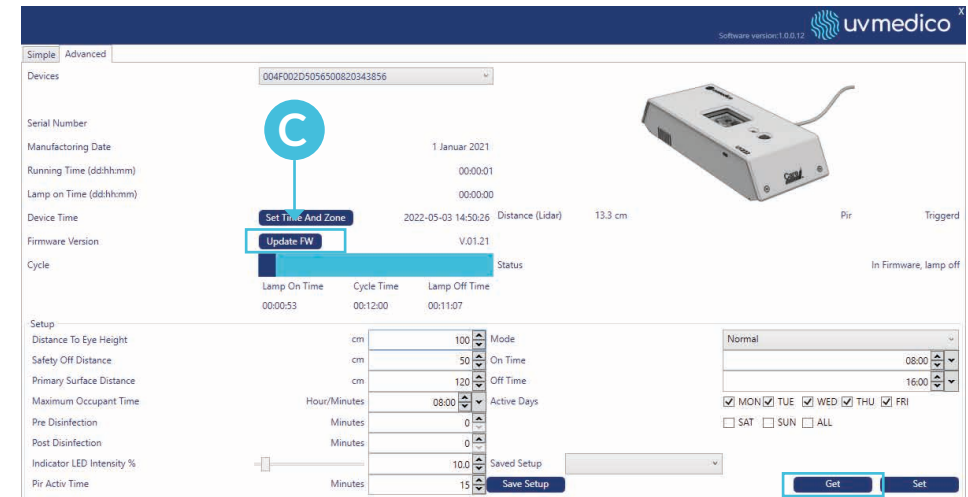

Select the correct version **A** and click on “Open” to upload it. Then confirm by clicking “Yes.” **B**
 When finished installing, the firmware should be up to date.

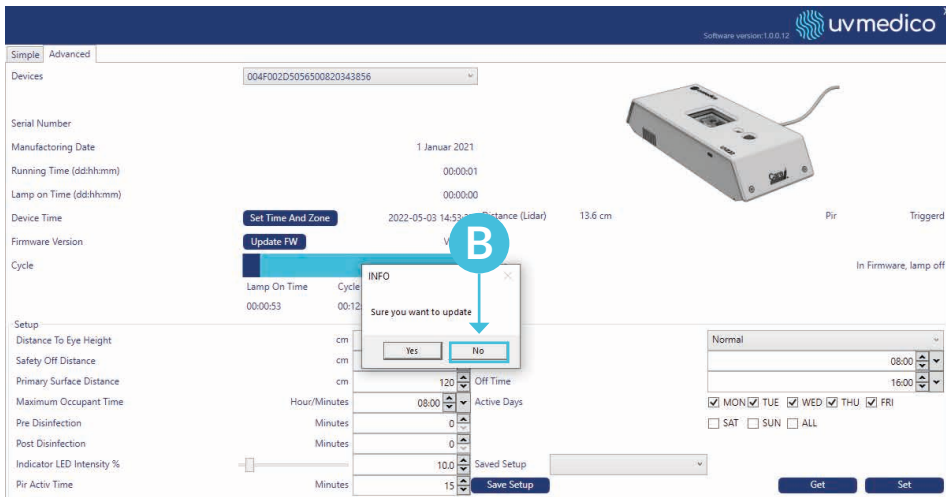
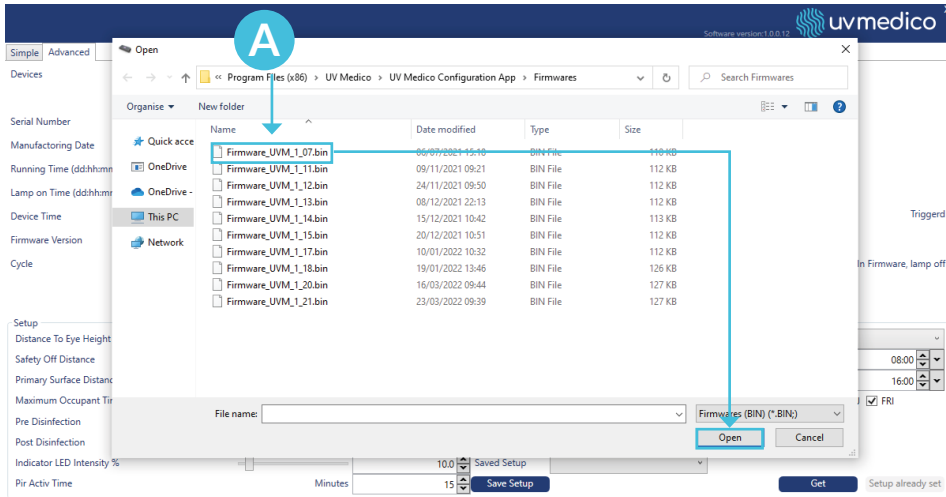

- 3) Set the correct hour by pressing “Set Time and Zone.” **C**
 The date and hour are now the same as your computer.
- 4) Define the timing of the use (duty cycle) of the room where the Product is installed:
 “On time”: Time from which the room will be occupied by people. **D**
 “Off time”: Time from which the room will not be occupied. **E**
- 5) Add the “Maximum Occupant Time”: how long the room is occupied during the duty cycle. **F**

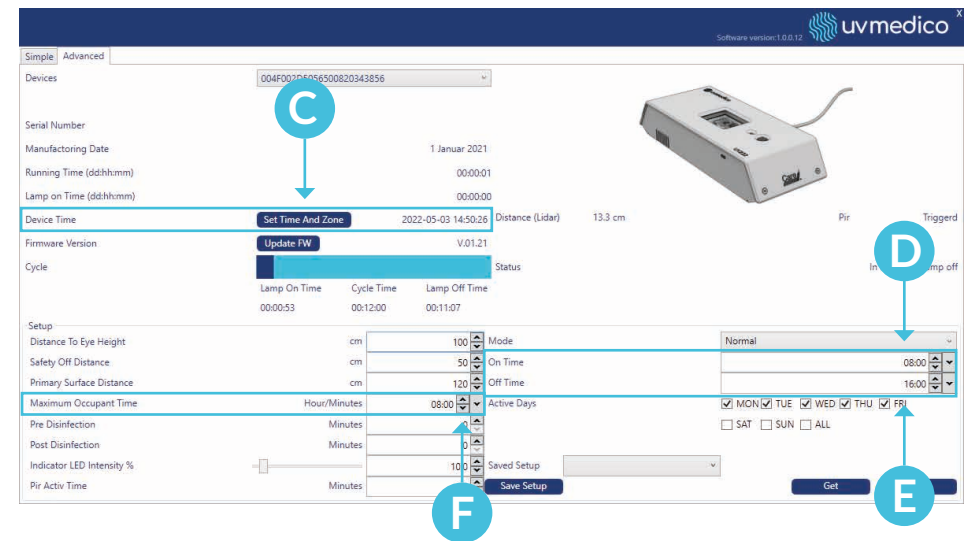

- 6) Add the pre and post cleaning cycle, if desired. **A** The unit will then light up before and after the duty cycle.
- 7) Change the intensity of the multicolour LED to the desired output. **B**
- 8) Select mode. **C**
 - “Normal”: The Product will follow the settings as provided.
 - “Only on when movement”: The Product only will turn on when the Pir sensor detects movement. The “Pir active time” option allows to set how many minutes the cycle will run after movement is detected.
 - “Always on, only ‘Safety off distance’ is enabled”: The Product will only turn off when something gets closer than the selected safety off distance.

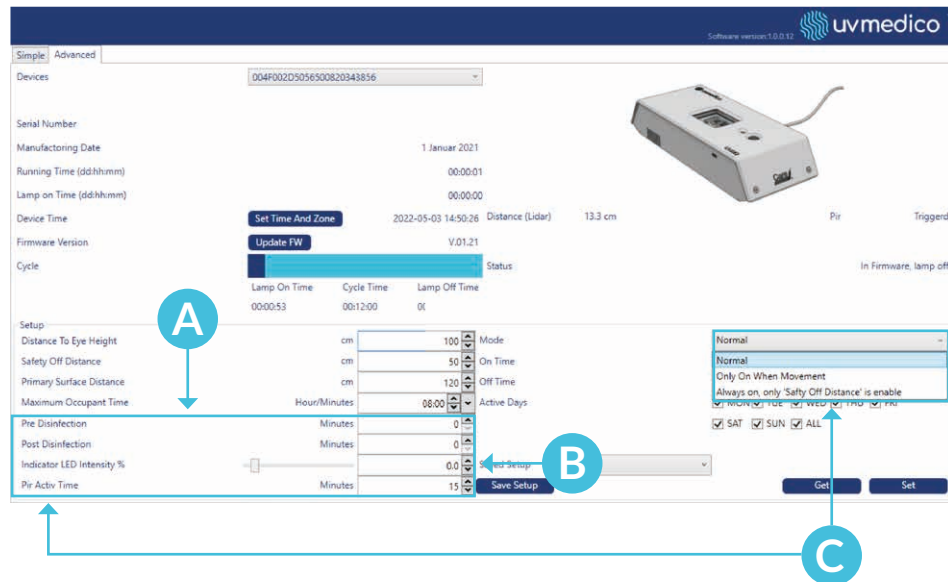

- 9) Add 3 distances:
 - a. “Distance to eye height”: Closest distance of the unit to the eye of a human (even with people walking around). **D**
 - b. “Safety off distance”: Closest distance people are allowed to get to the lamp before it turns itself off. The unit will turn itself back on after 10 sec. when/if the safety distance is regained. **E**
 - c. “Primary surface distance”: Distance from the unit to the main surface to disinfect. **F**

All measurements are in centimetres.

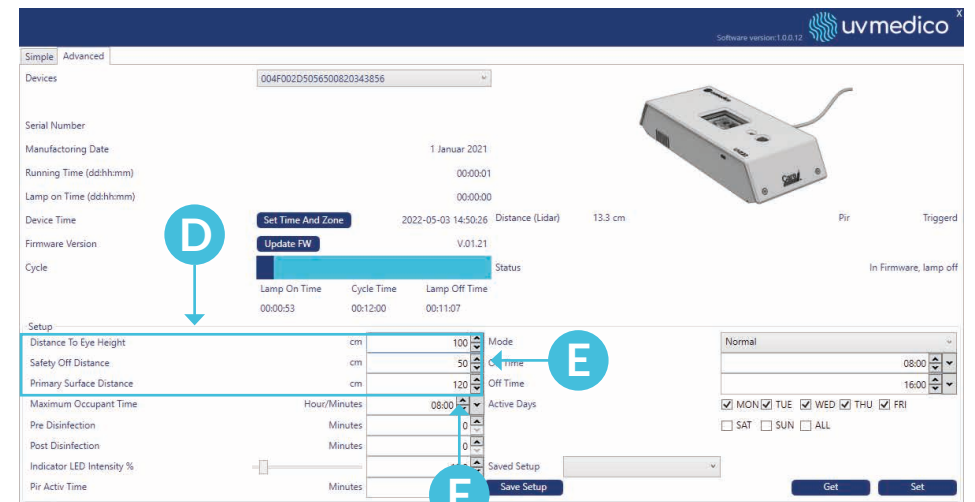

- 10) Save setup into template by pressing “Save Setup”. **A**
Name the template. This can be recalled whenever you have similar settings.

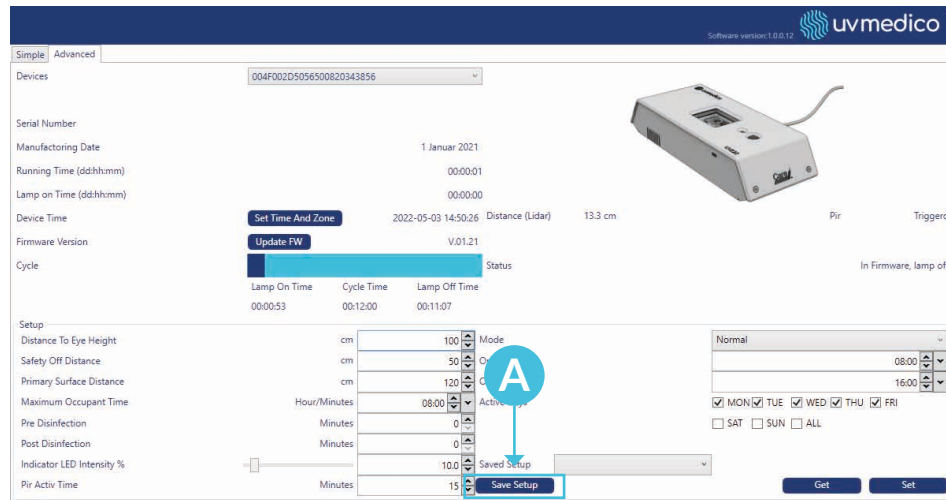

- 11) Press “Set” to upload the settings into the Product. **B**

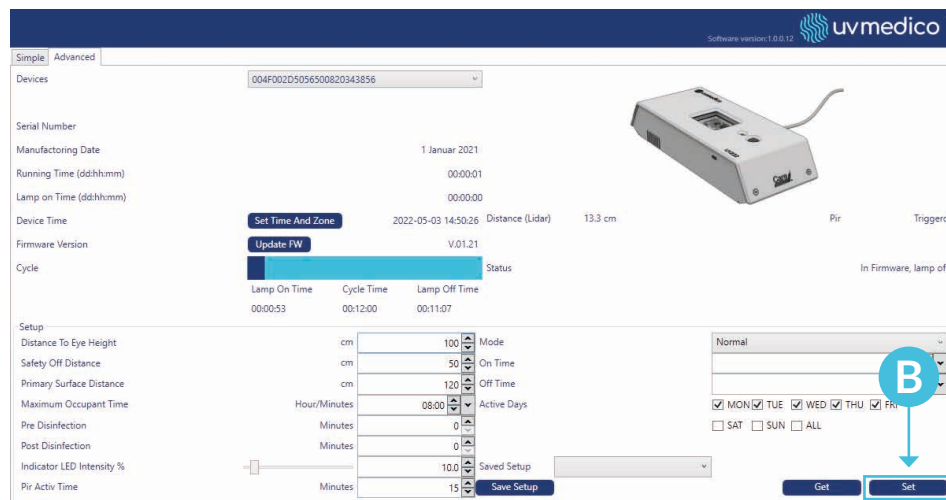

Once this information is saved and programmed into the unit, it is ready to test/start up.

The unit will calculate the radiation automatically to stay within the limits of the ACGIH like the example below:

If during the duty cycle a person comes closer to the unit than the programmed distance to the eye, the Product will automatically stop, and it will resume the activity 10 sec. after this security distance is cleared.



If during the duty cycle, something/someone comes closer to the unit than the programmed safety off distance, the Product will automatically stop, and it will resume the activity 10 sec. after the security distance is cleared.

If movement in the room is detected during the pre or post disinfection cycle, the unit will start its duty cycle again, and will resume its pre or post disinfection cycle after no more movement is detected.

If the information programmed into the Product when installed is different than the use/occupancy of the room, UV Medico A/S cannot be held liable for any injuries or misuse of these units.

If the room changes of use, occupancy or any change that has an influence on the risks of exposure, the installer needs to be contacted so the Product is reprogrammed.

11) Testing the Product.

Right click on the photo of the Far UV-C unit **A** and a pop up of the test mode will show up.

Here you can quickly light up the Product and test the signal LED.

When you activate the 222 LightSource **B**, it will turn on the Product with **no safety**. This is only to test the source, (the box "Enable" will be automatically ticked).

When you go to LED Mode you have 3 possibilities to choose:

- "Normal Mode": Work as the Product is programmed.
- "LED Off": Turns the LED off.
- "LED RGBW Off": LED test cycle.

When you untick the "Enable" box it goes back to normal configuration/use.

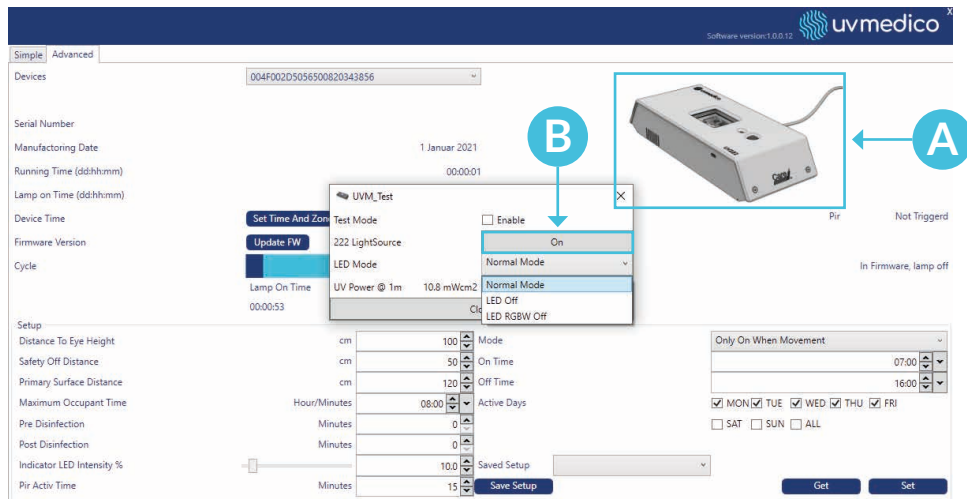

6.6. Understanding the function of the signal LED

LED	MEANING
No light	No power.
Red continuous	Error: no feedback from the Product light source.
Cyan continuous	Pre disinfection / after disinfection light source on.
Magenta continuous	Light source is on.
Blue continuous	In-cycle UV off.
Green continuous	Out of cycle.
Flashing red	Object too close.
Flashing magenta	Pre disinfection / after disinfection per seen movement.
Red-blue-green (loop)	Recommended change of Far UV-C light source.

6.7. Replacements

The Product has an internal battery and fuse that can be replaced if broken or empty.

Take the unit off the installation panel locate the USB-C connector **C**. The panel to remove is the one to the left. Unscrew the 4x screws **D** and take off the cover **E**. You will see the fuse (T250 V 500 mA) and battery (3 V CR2032). Replace only with correct fuse and battery to prevent damage.

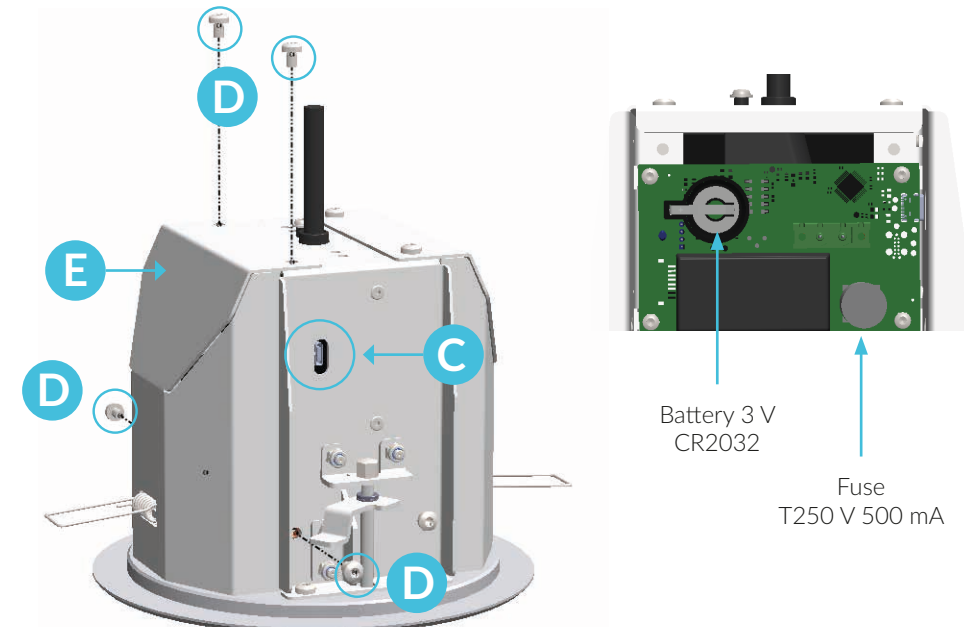

7. PRODUCT FAILURE

FAILURE	TO DO
Unit does not light up	Check incoming power. Check cable damage. Replace fuse. Check if the Product is correctly installed.
Unit flickers	Check if the Product is correctly installed. If not, contact your local distributor.
White flash	Power cycle the unit.
Does not hold settings	Replace battery.

If the failure is unsolved or recurring, please return the unit to an official UV Medico dealer/ service centre for repair or replacement (see point **10. REPAIRS**).

8. CLEANING AND MAINTENANCE

Clean the external surfaces with a soft cloth and non-aggressive cleaning agents only.

Before performing any maintenance always unplug the Product and disconnect the power supply.



CAUTION: Turn off and lock out ALL unit power before performing any cleaning. Do not wash the Product with a pressure washer or by immersion.

9. LIGHT SOURCE REPLACEMENT

UV Medico A/S recommends replacing the Far UV-C light source when LED signals red-blue-green (loop).

Contact your supplier/installer for replacement. The unit has no user-serviceable parts.

10. REPAIRS

If the Product is damaged, malfunctions, or for other specific inquiries, please contact your authorised UV Medico distributor.

11. RECYCLING & DISPOSAL

Our products can be disassembled into separate materials of four recycling categories for minimal waste: metal, plastic, electronics, and light bulbs.

If you have any problems to dispose of our products at the end of life, you are welcome to send them back to us for recycling and disposal according to local regulations.

Warranty

2-year warranty is given from invoice date regardless on the hours the unit is used.

UV222™ and its logo are registered trademarks of UV Medico A/S. All rights reserved. No part of this manual may be copied or published by means of printing, photocopying, microfilm or otherwise without the prior written consent of the manufacturer. This restriction also applies to the corresponding drawings.

The information given in this manual has been collected for the general convenience of our customers. It has been based on general data pertaining to construction material properties and working methods known to us at the time of issue of the manual and is therefore subject at any time to change or amendment, and the right to change or amend is hereby expressly reserved. The instructions in this manual only serve as a guideline for installation, use, maintenance and repair of the Product mentioned on the cover page of this document. This manual is to be used for the standard model of the Product of the type given on the cover page. Thus, the manufacturer cannot be held responsible for any damage resulting from the application of this manual to any other product.

This manual has been written with great care. However, the manufacturer cannot be held responsible, either for any errors occurring in this manual or their consequences.



UV Medico A/S
Søren Frichs Vej 50
8230 Åbyhøj
Denmark

+45 20 90 71 30

info@uvmedico.com
www.uvmedico.com